

CM50DU-24F

HIGH POWER SWITCHING USE

CM50DU-24F



- IC 50A
- VCES 1200V
- Insulated Type
- 2-elements in a pack

APPLICATION

General purpose inverters & Servo controls, etc

OUTLINE DRAWING & CIRCUIT DIAGRAM

Dimensions in mm

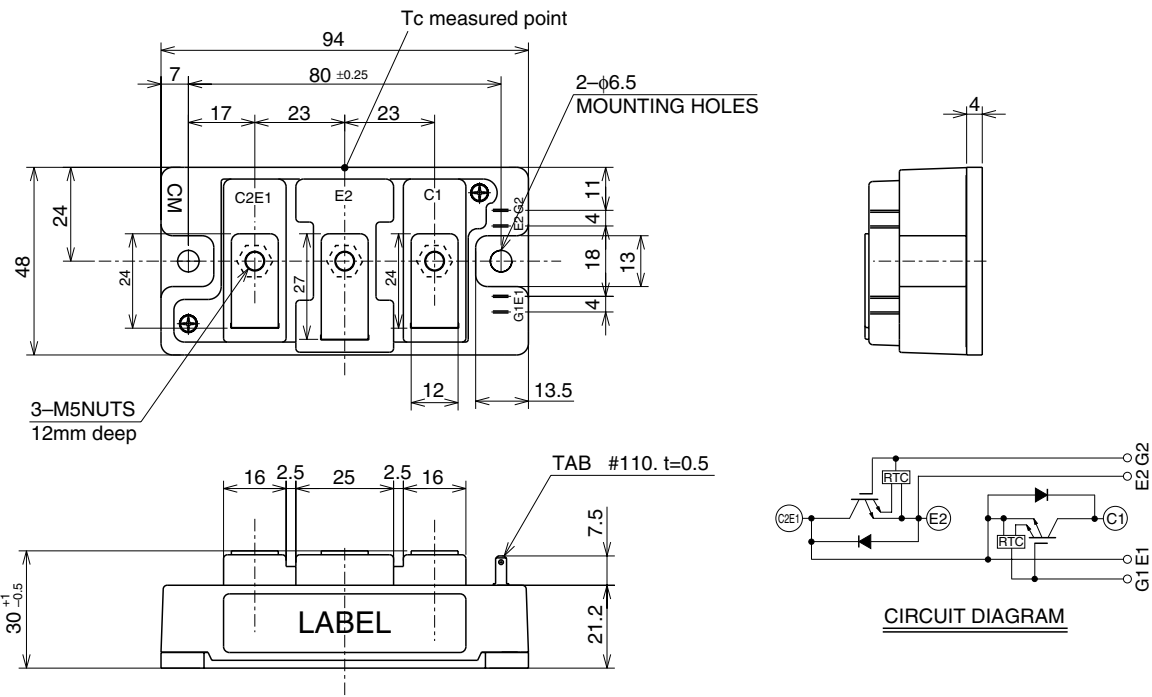

CM50DU-24F

HIGH POWER SWITCHING USE

MAXIMUM RATINGS (T_j = 25°C, unless otherwise specified)

Symbol	Parameter	Conditions	Ratings	Unit
V _{CE} S	Collector-emitter voltage	G-E Short	1200	V
V _{GE} S	Gate-emitter voltage	C-E Short	±20	V
I _C	Collector current	T _c = 25°C	50	A
I _{CM}		Pulse (Note 2)	100	A
I _E (Note 1)	Emitter current	T _c = 25°C	50	A
I _{EM} (Note 1)		Pulse (Note 2)	100	A
P _C (Note 3)	Maximum collector dissipation	T _c = 25°C	320	W
T _j	Junction temperature		-40 ~ +150	°C
T _{stg}	Storage temperature		-40 ~ +125	°C
V _{iso}	Isolation voltage	Charged part to base plate, f = 60Hz, AC 1 minute	2500	V _{rms}
—	Torque strength	Main terminals M5 screw	2.5 ~ 3.5	N • m
		Mounting M6 screw	3.5 ~ 4.5	N • m
—	Weight	Typical value	310	g

ELECTRICAL CHARACTERISTICS (T_j = 25°C, unless otherwise specified)

Symbol	Parameter	Test conditions	Limits			Unit
			Min.	Typ.	Max.	
I _{CE} S	Collector cutoff current	V _{CE} = V _{CE} S, V _{GE} = 0V	—	—	1	mA
V _{GE(th)}	Gate-emitter threshold voltage	I _C = 5.0mA, V _{CE} = 10V	5	6	7	V
I _{GES}	Gate leakage current	±V _{GE} = V _{GES} , V _{CE} = 0V	—	—	20	μA
V _{CE(sat)}	Collector-emitter saturation voltage	I _C = 50A, V _{GE} = 15V	T _j = 25°C		2.4	V
			T _j = 125°C		—	
C _{ies}	Input capacitance	V _{CE} = 10V V _{GE} = 0V	—	—	20	nF
C _{oes}	Output capacitance		—	—	0.85	nF
C _{res}	Reverse transfer capacitance		—	—	0.5	nF
Q _G	Total gate charge	V _{CC} = 600V, I _C = 50A, V _{GE} = 15V	—	550	—	nC
t _{d(on)}	Turn-on delay time	V _{CC} = 600V, I _C = 50A V _{GE} = ±15V R _G = 6.3Ω, Inductive load I _E = 50A	—	—	100	ns
t _r	Turn-on rise time		—	—	50	ns
t _{d(off)}	Turn-off delay time		—	—	300	ns
t _f	Turn-off fall time		—	—	300	ns
t _{rr} (Note 1)	Reverse recovery time		—	—	150	ns
Q _{rr} (Note 1)	Reverse recovery charge		—	2.1	—	μC
V _{EC} (Note 1)	Emitter-collector voltage	I _E = 50A, V _{GE} = 0V	—	—	3.2	V
R _{th(j-c)Q}	Thermal resistance*1	IGBT part (1/2 module)	—	—	0.39	K/W
R _{th(j-c)R}		FWDi part (1/2 module)	—	—	0.70	K/W
R _{th(c-f)}	Contact thermal resistance	Case to heat sink, Thermal compound applied*2 (1/2 module)	—	0.07	—	K/W
R _{th(j-c)Q}	Thermal resistance	Case temperature measured point is just under the chips	—	—	0.31*3	K/W
R _G	External gate resistance		6.3	—	63	Ω

Note 1. I_E, V_{EC}, t_{rr}, Q_{rr} & die/dt represent characteristics of the anti-parallel, emitter-collector free-wheel diode (FWDi).

2. Pulse width and repetition rate should be such that the device junction temperature (T_j) does not exceed T_{jmax} rating.

3. Junction temperature (T_j) should not increase beyond 150°C.

*1 : Case temperature (T_c) measured point is indicated in OUTLINE DRAWING.

*2 : Typical value is measured by using thermally conductive grease of λ = 0.9[W/(m • K)].

*3 : If you use this value, R_{th(f-a)} should be measured just under the chips.

PERFORMANCE CURVES

OUTPUT CHARACTERISTICS (TYPICAL)

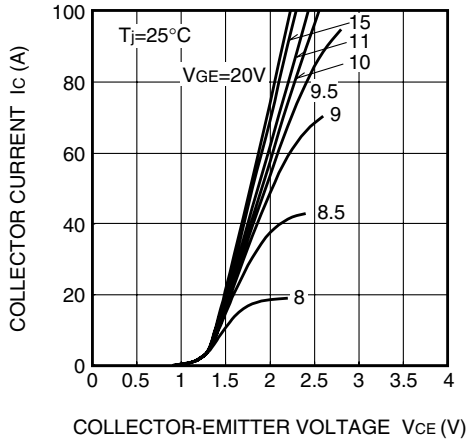

COLLECTOR-EMITTER SATURATION VOLTAGE CHARACTERISTICS (TYPICAL)

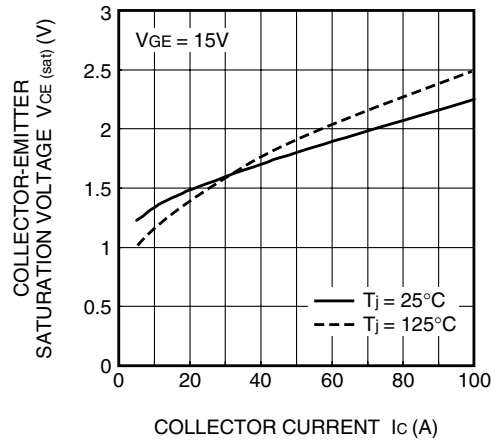

COLLECTOR-EMITTER SATURATION VOLTAGE CHARACTERISTICS (TYPICAL)

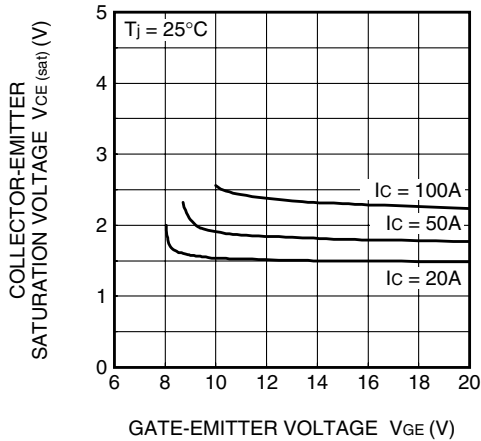

FREE-WHEEL DIODE FORWARD CHARACTERISTICS (TYPICAL)

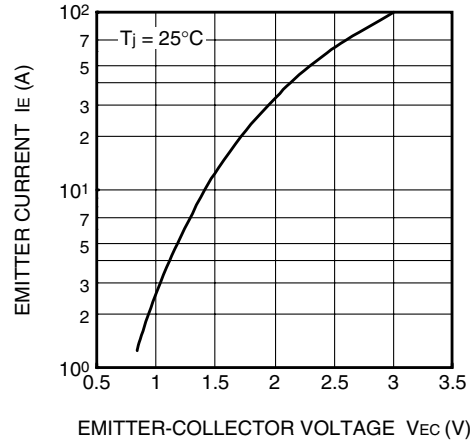

CAPACITANCE- V_{CE} CHARACTERISTICS (TYPICAL)

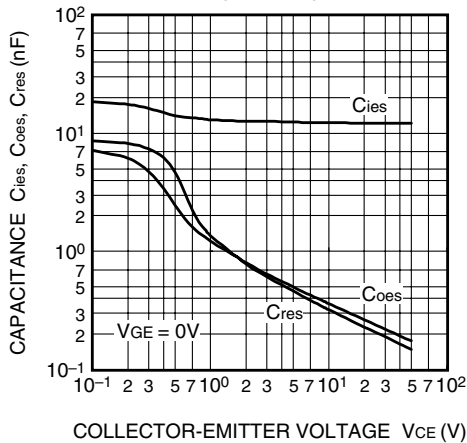

HALF-BRIDGE SWITCHING CHARACTERISTICS (TYPICAL)

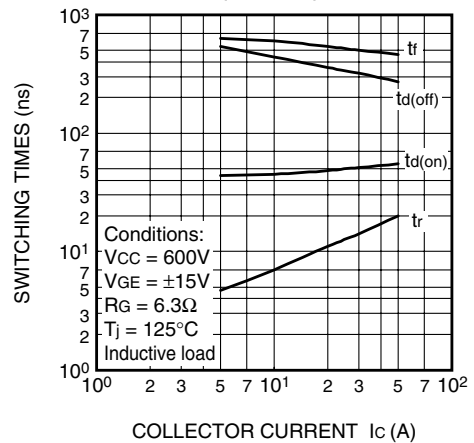

REVERSE RECOVERY CHARACTERISTICS OF FREE-WHEEL DIODE (TYPICAL)

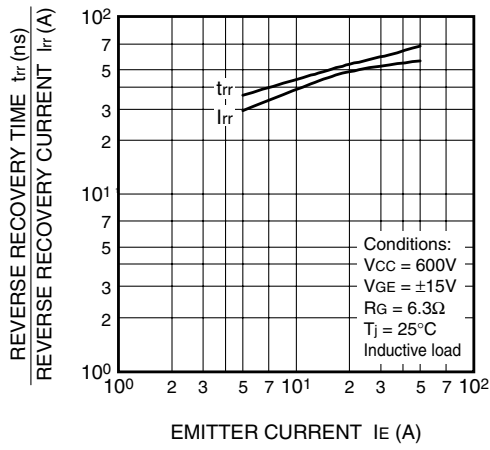

TRANSIENT THERMAL IMPEDANCE CHARACTERISTICS (IGBT part & FWDi part)

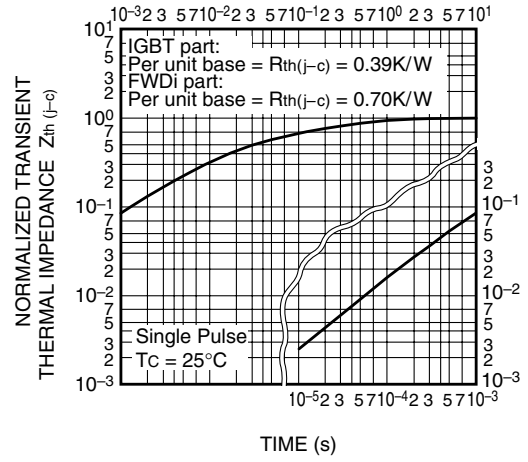

GATE CHARGE CHARACTERISTICS (TYPICAL)

